

An aerial view of a sustainable village. The scene features several white, cylindrical houses with arched openings, arranged in a cluster. A paved path winds through the green landscape, where people are seen walking and a person is riding a bicycle. In the background, there is a large solar panel array and a tall white wind turbine. The sky is bright with some clouds and birds flying. The overall atmosphere is one of a modern, eco-friendly community.

Village-in-a-Box

OUR VISION

" communities that are resilient, sustainable, safe and ready for the future "

Cities of the future

- **Sustainable**, climate-ready, **interconnected** and smart
- **Resilient**, supplying all **basic human needs**
- Heavily based on automation, robotics, **autonomous** devices

What if we can start now?



Infrastructure as a key



Infrastructure is inefficient, polluting and costly

By not recycling all resources locally – money is wasted and more pollution created on the expense of residents



There are many cleantech systems today



There is a need to connect

Physical
Software
Logistics
Business
Regulation



Infrabox platform

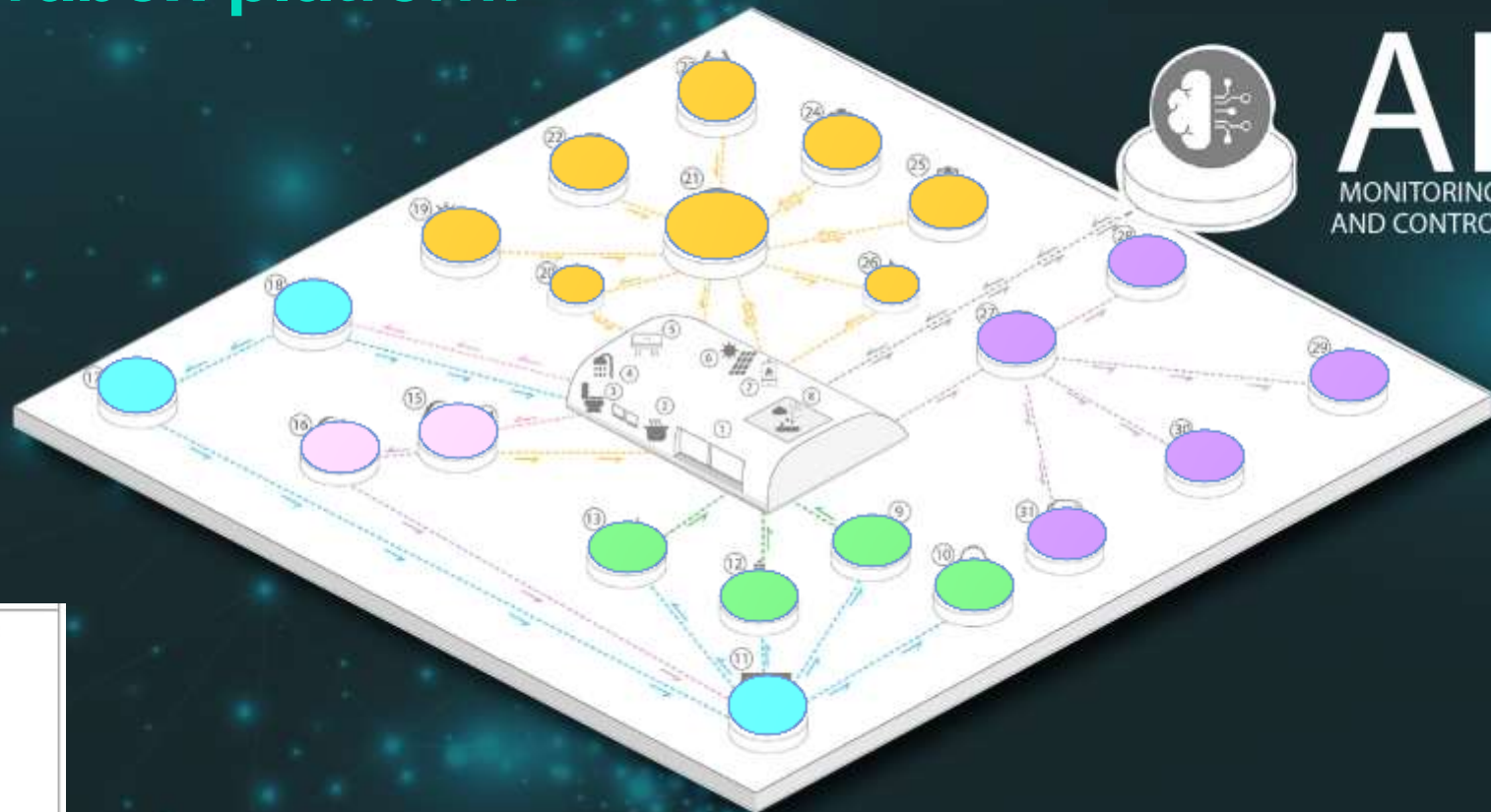

Infrabox | Circular infrastructure

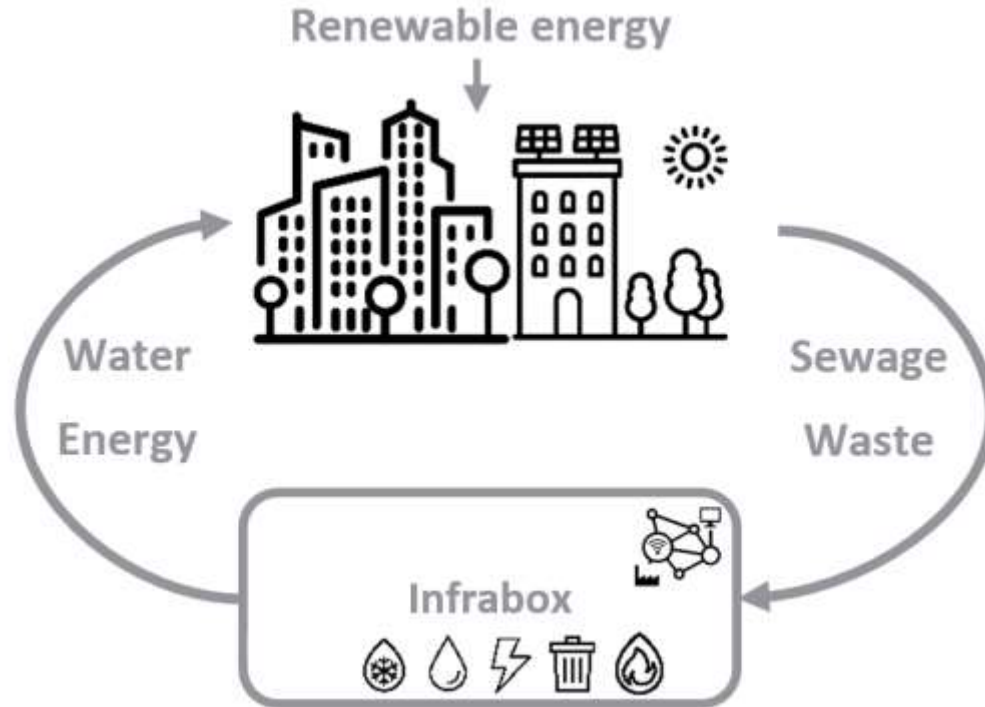

Infrabox | Circular infrastructure

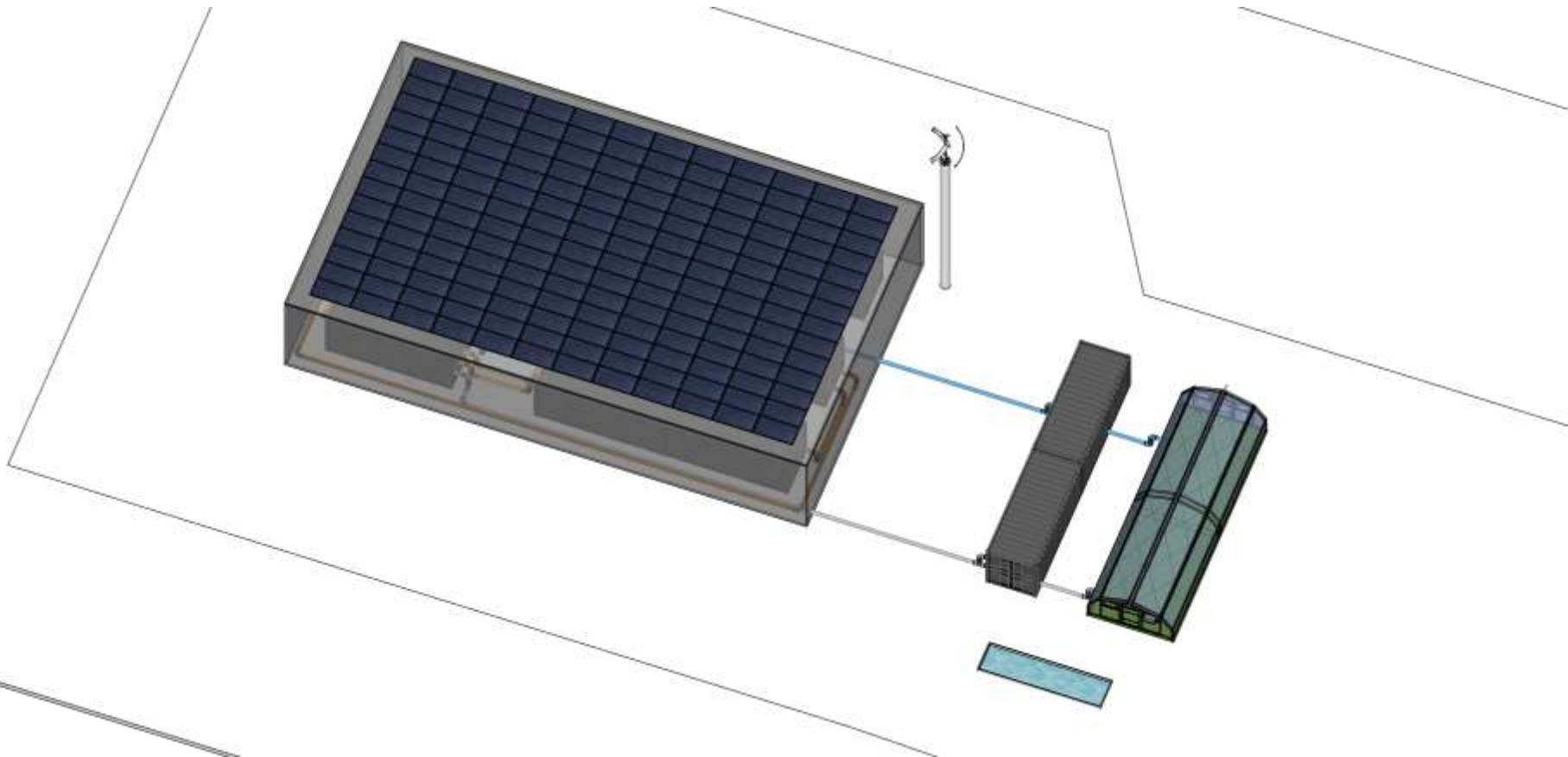

Infrabox | Circular infrastructure

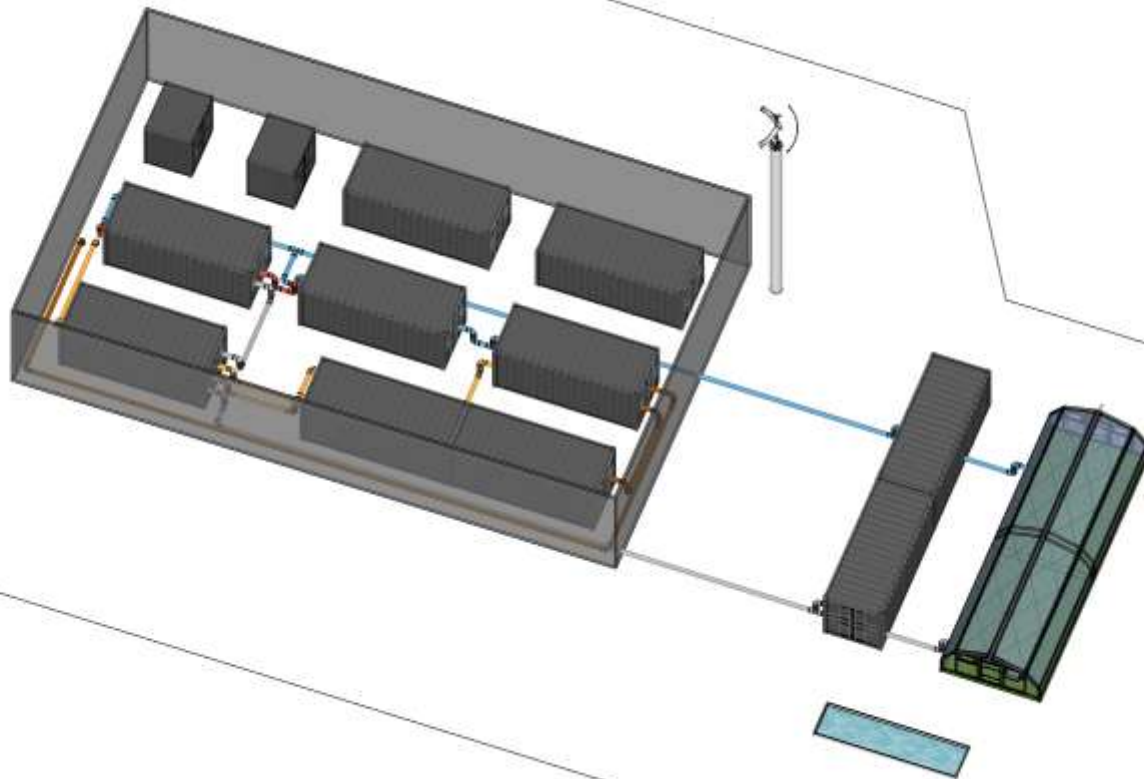

Infrabox | Circular infrastructure

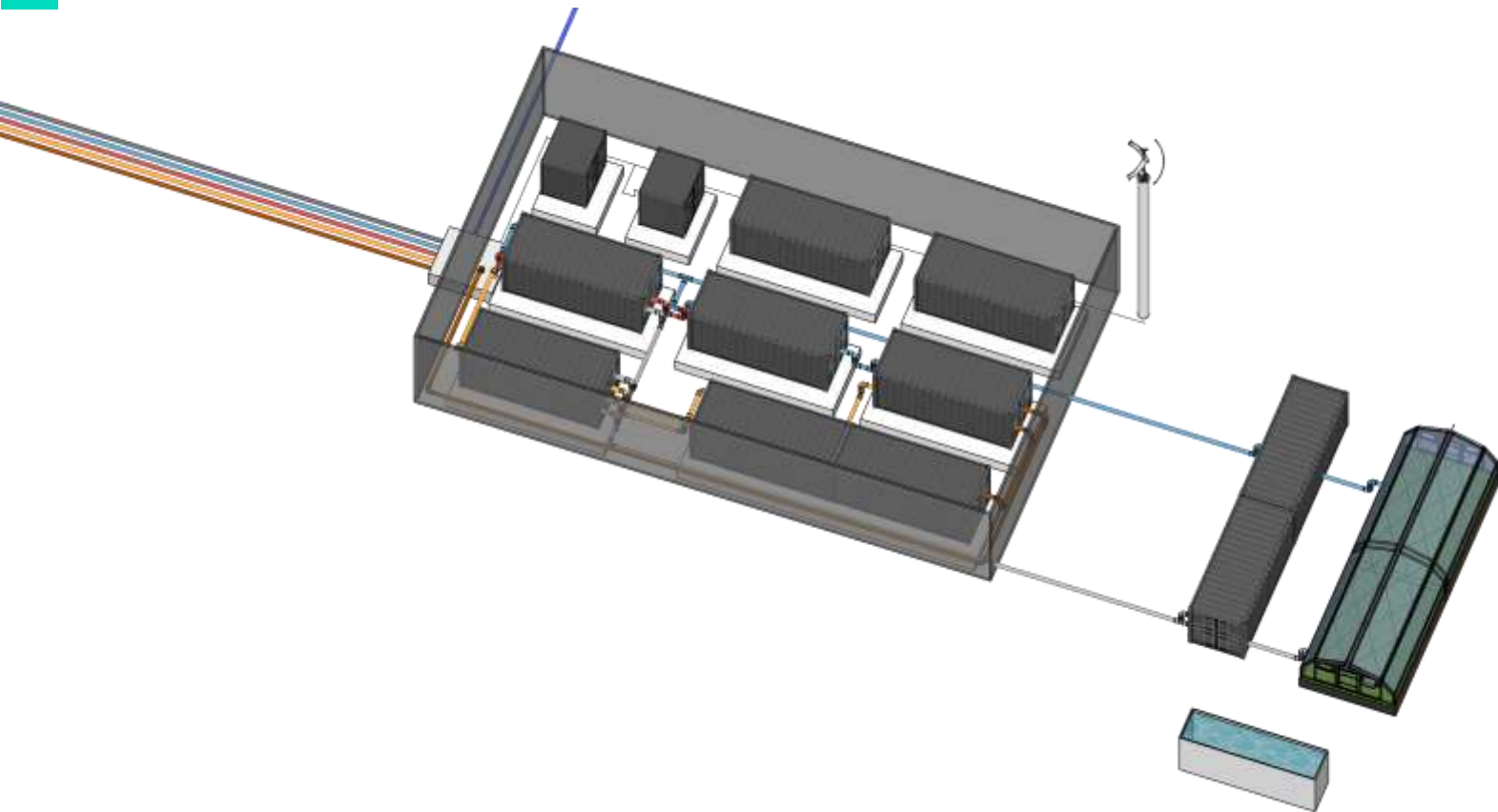

Infrabox | Installation settings

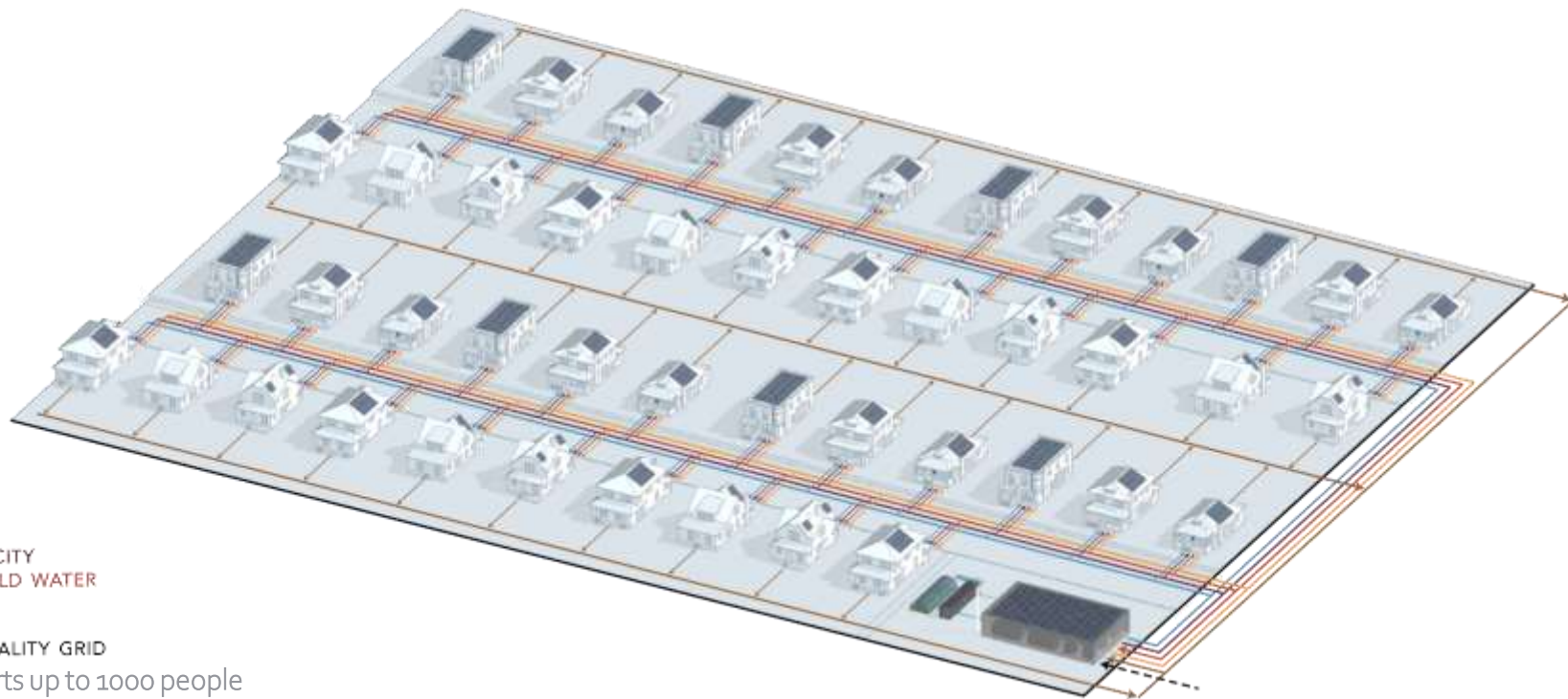

WATER
ELECTRICITY
HOT/COLD WATER
BIOGAS
SEWAGE
MUNICIPALITY GRID

Supports up to 1000 people

Village in a box

Recycling waste, sewage
Generating & storing energy
Powered by AI Control Software



AIES Self-sustained
Campus



Infrabox | Smart operation

- ✓ Forecast
- ✓ Stabilized AI control & monitoring
- ✓ Diversified storage
- ✓ Virtual storage
- ✓ Maintenance / task management
- ✓ Modular and scalable



28,000
m³
water recycled

540
Ton
waste recycled

9.7 M
kWh clean
energy generated

85 Ton
Food
Grown

6190
Ton CO₂
avoided

Mitzpe Ramon Project

SIEMENS
Ingenuity for life



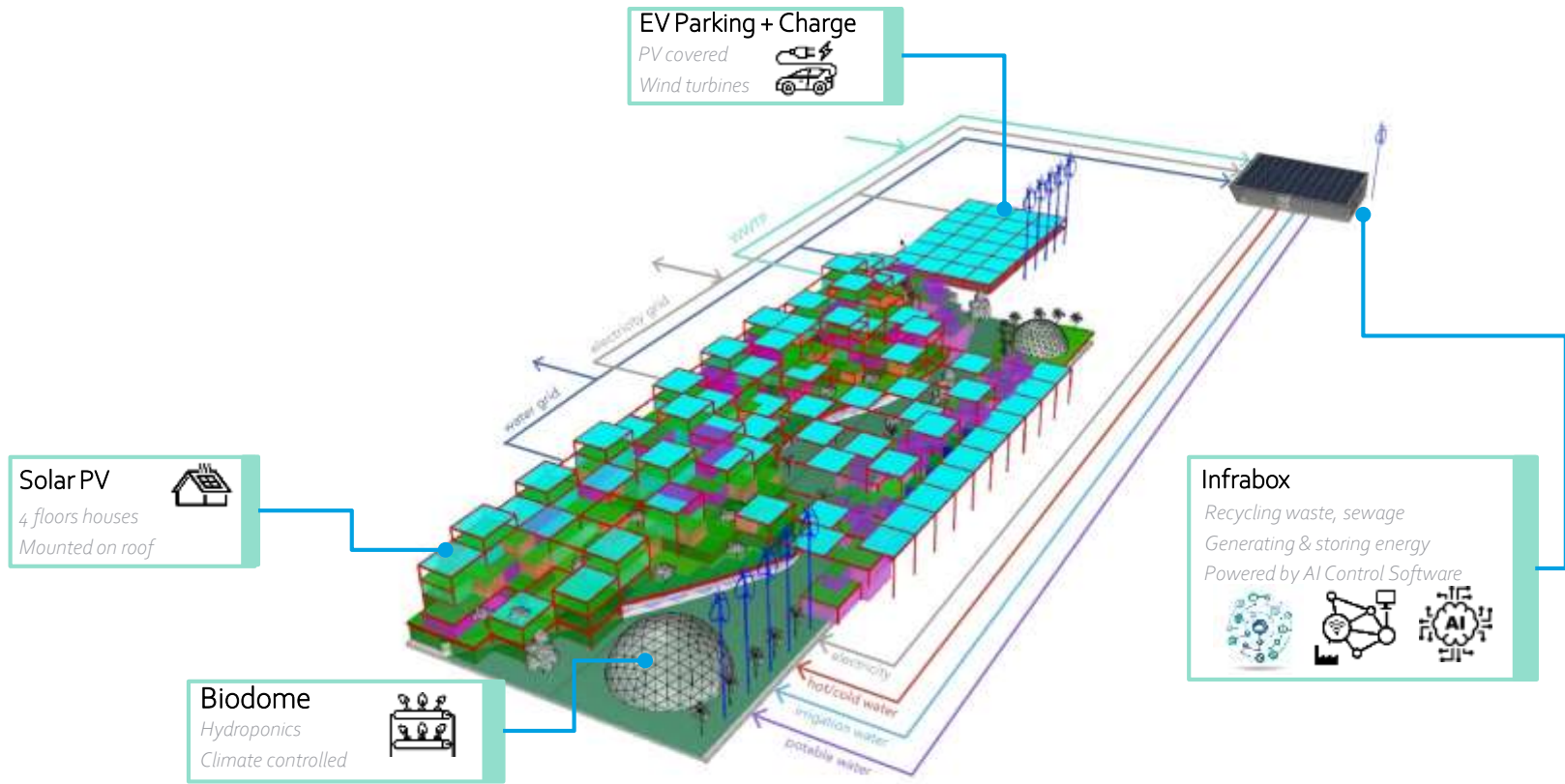
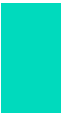

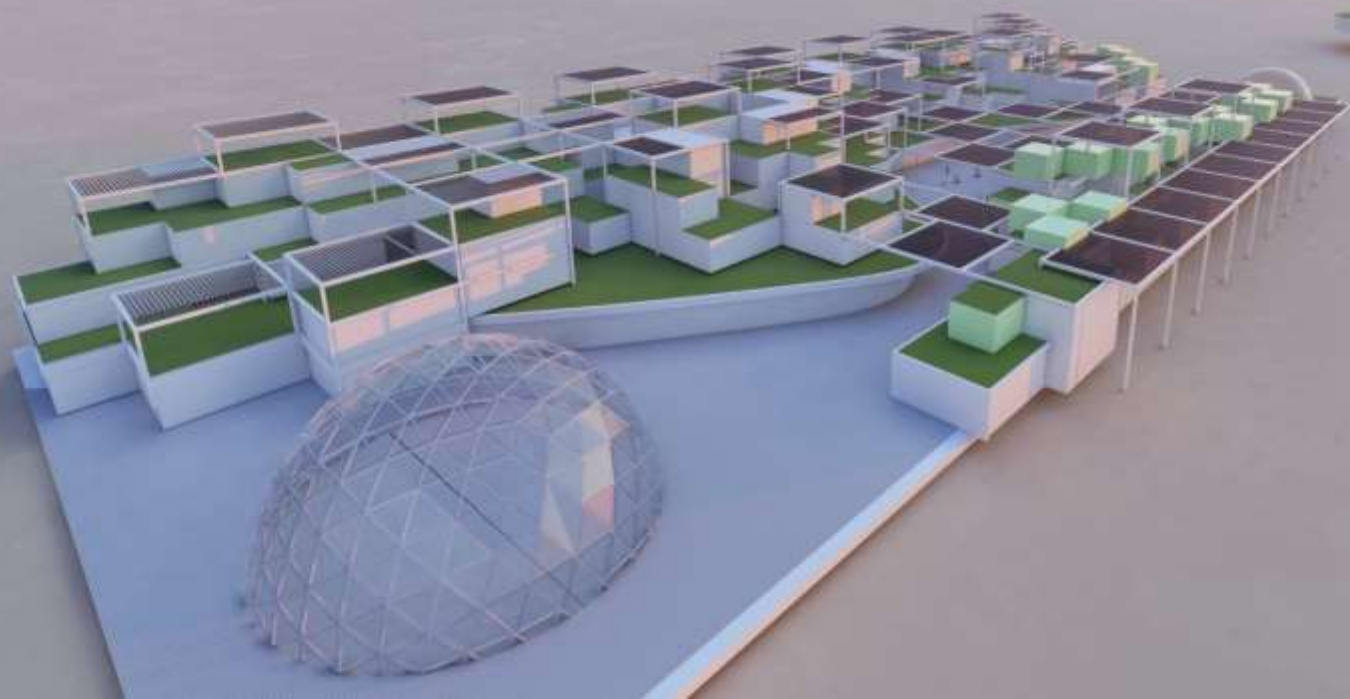





Our Partners

Infrastructure Partners



Industry Backers & Clients



Awards



\$160,000

Breakthrough
Technology Grant



Diamondlist.co

Best climate-startups



Israel Winner
2019



DeserTech
Climate Technologies Community

Israel Winner
2020



\$340,000
Pilot Grant



Thank You

Please get in touch

yonis@sustainable.co.il



2 ZERO HUNGER



6 CLEAN WATER AND SANITATION



7 AFFORDABLE AND CLEAN ENERGY



9 INDUSTRY, INNOVATION AND INFRASTRUCTURE



11 SUSTAINABLE CITIES AND COMMUNITIES



13 CLIMATE ACTION

